







WN
WINDOW NATION
WINDOWS • SIDING • DOORS

ADDISON SERIES | REPLACEMENT WINDOWS AND DOORS

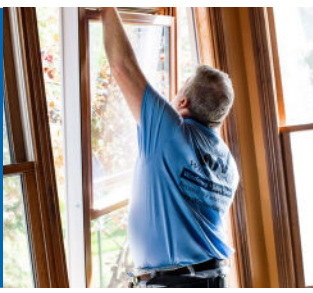
WHY WINDOW NATION?

Over 1,500,000 windows installed in more than 150,000 homes

Attention to Detail		<ul style="list-style-type: none">• Detailed quality audits every hour on every manufacturing line• 20-point installation review• 96% customer satisfaction on clean up and safety• Custom windows measured to the tightest tolerance in the industry• Over 1.5 million windows installed with 96% requiring no follow up service
Quality		<ul style="list-style-type: none">• Window Nation uses America's only integrated system of window installation materials, insulation, sealant, and caulking• OSI Quad Foam• OSI Quad Max exterior sealant• Ultra-premium, high-performance exterior trim coil• Concrobium mold spray treatment
Experience		<ul style="list-style-type: none">• Installation crew leaders average more that 20,000 windows and over a decade experience• Service technicians average 15 years of experience• Over 1.5 million windows installed in over 150,000 homes• 3rd largest window dealer in the country, ranked by Window and Door Market Magazine
Product Selection		<ul style="list-style-type: none">• Over 1,500 custom window and door style combinations• Name brand windows available• Energy Star®-qualified products• Windows engineered for the specific climate you live in
Trust		<ul style="list-style-type: none">• Angi™ Super Service award winner• Limited Lifetime Warranty• Exclusive 30-Day Price Protection Guarantee• Licensed, bonded, and insured



THE WINDOW NATION FOUNDERS STORY

At Window Nation, we know replacement windows. We're third-generation window replacement experts who have been lucky to provide homeowners replacement windows, siding, and doors for over fifteen years. Our co-founders Harley and Aaron Magden grew up in the window replacement industry, learning the business from the ground up. We opened our first showroom in Maryland in 2006, quickly growing to serve homeowners in cities across the country – and we're not stopping there. We're grateful for every homeowner who has trusted us to upgrade their most important asset: their home.

We've learned a lot about home improvement over the years, but the most important thing we learned isn't about window replacement. We learned the home improvement industry isn't about offering the best windows, siding and doors; it's about the relationships we build with our customers. Your home is your most important asset, and we don't take the opportunity to work with you lightly. There's nothing more important to us than providing high-quality windows, siding and doors to help you turn your house into your dream home.

Our team at Window Nation will go the extra mile to ensure your project goes smoothly. We pride ourselves on our attention to detail, and you can feel comfortable knowing you're working with one of the most experienced, detail-oriented teams in the industry. Our team undergoes hours of ongoing training and education on the latest technology, products, and techniques to ensure our company exceeds your expectations.

Our goal at Window Nation is to help our customers find the perfect windows, siding and doors for their home. We want our customers to feel good about their decision to work with our company, and our team will go above and beyond to ensure you have the best possible experience. Our exterior design consultants are specially trained in the best practices in window replacement, helping you find the perfect fit for your home and wallet. We offer a variety of window styles, custom-made to fit your home's unique needs. When you choose replacement windows from Window Nation, you'll enjoy a curb appeal boost while keeping your home comfortable no matter the season. All Window Nation products are Energy Star certified, saving you money on your energy bills no matter the season.

There are many home improvement companies eager for your business, and we're honored you're considering Window Nation for your project. We don't take your decision to work with our team lightly, and we look forward to helping you find the perfect windows, siding, and doors for your home.

What our customers are saying

"Wow! So happy with our purchase and couldn't recommend more! After being stressed with so many estimates we found Ryan. Ryan sat with us and explained every aspect of the process and most important the quality of everything they'd do and they delivered. The windows look beautiful and the installers were all so kind and trustworthy. We are so happy with our purchase and highly recommend Window Nation!"

- Gina S.

HARLEY MAGDEN
Co-Founder



AARON MAGDEN
Co-Founder

ENGINEERED TO PERFORM

ADDISON DOUBLE-HUNG WINDOW

Our top-of-the-line Addison double-hung window delivers the best of both worlds, with design details, like our stylish beveled sashes, and energy-efficient options, such as insulated dual-pane glass and heavy-duty weatherstripping. It's thoughtful engineering and aesthetic details like these that make the Addison double-hung the ideal replacement window for any remodeling or renovation project.

Best-in-class features:

- 1 Welded, heavy-duty vinyl construction provides superior strength and durability while multiple hollow chambers in the mainframe create sealed air spaces for an effective insulating barrier.
- 2 The beveled exterior edge adds style and curb appeal to an already sleek design.
- 3 Double-strength insulated glass unit creates a sealed air space between the panes that is enhanced by our warm-edge spacer system and argon gas enhancement.
- 4 Metal-reinforced meeting rail delivers superior strength and durability.
- 5 Recessed, opposing cam locks evenly secure your window without interrupting sight lines.
- 6 Heavy-duty weatherstripping and interlocking sashes help to keep weather and wind outside.
- 7 Recessed tilt latches can be released to tilt both top and bottom sashes into the home for easy cleaning.
- 8 Detent clip keeps the top sash from drifting while an inverted-coil balance system ensures both sashes will stay where you put them, no matter the position.
- 9 Balance channel covers help achieve a polished and refined look.
- 10 Push-button vent latches allow for overnight ventilation while giving you added peace of mind.
- 11 Welded combination sill featuring a deflection leg enhances rigidity and a five-degree sloped sill directs water away from the home and eliminates unsightly weep holes.
- 12 Full-length, integrated ergonomic lift rails provide convenient, easy operation. Bevel on bottom rail makes gripping easy.



GLAZING TYPE	U-VALUE	SHGC
Argon and Low-E glass	0.27	0.28
Argon and HP Low-E glass	0.27	0.21
Argon and Low-E triple-pane glass	0.22	0.25

ADDISON PLUS SERIES WINDOWS*

Enjoy the style and security of our Addison window with increased performance and energy-efficiency. The Addison Plus package includes a foam-filled mainframe that improves the thermal and structural performance of the window. It also features fiberglass reinforcements in the meeting rail to reduce heat and cold transfer while providing enhanced strength and durability.

Also, the Addison Plus window offers custom finish options. Choose from three interior woodgrains and eight exterior paint colors; see back page for details.

* Double-hung and single-hung windows only

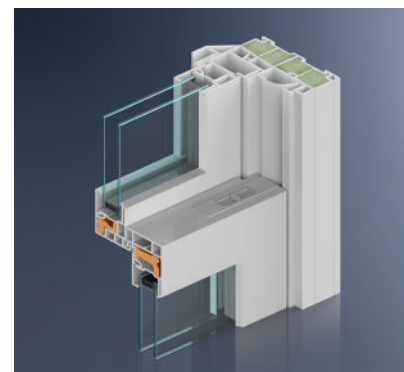

COMPLEMENTARY WINDOWS

We offer a complete series to accompany our Addison double-hung windows. In addition to our most popular Addison double-hung options, our replacement series consists of a single-hung, double-slider, awning, casement, fixed picture windows, and bay and bow windows as well as sliding glass doors. All of these products feature welded, multi-chambered vinyl frame and sash for superior strength and energy-efficiency. Dual-pane insulated glass with a warm-edge spacer system enhances each product's energy efficiency and improves seal performance.

Single-Hung



Double-Slider



Awning



Casement



Picture Window



BAY/BOW WINDOW

Bay and bow windows immediately add interest to any room. The outward projection opens up a room and adds dimension inside, while increasing the character and curb appeal of the home outside. Window Nation's bay and bow windows are engineered to be structurally sound and worry-free, while featuring a range of customizations and design elements to create a truly beautiful focal point. From custom copper roofs, recessed interior lighting, ornamental rosettes, and rich factory-stain finishes, a host of options are at your fingertips.

A variety of projection angles:

- Choose from 17", 21", 24", or 28" standard flankers, or specify a desired projection
- 15-, 30- or 45-degree Bay Window Styles
- 10- and 15-degree Bow Window Styles with your choice of three, four, or five lites



FLEXSCREEN

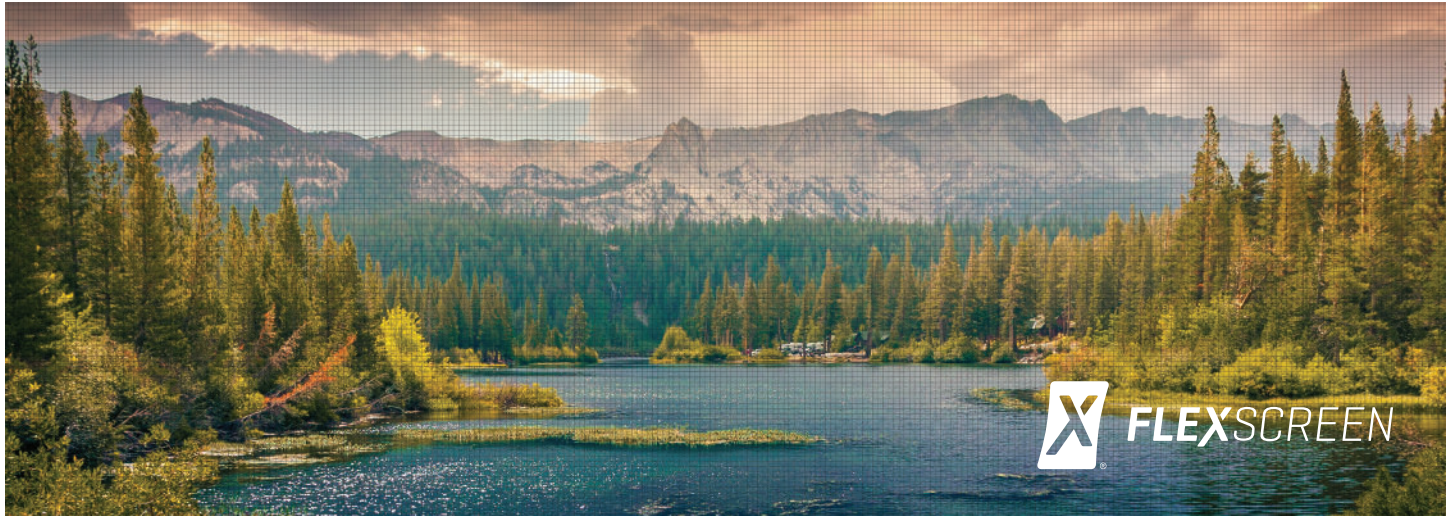

With FlexScreen, you can leave your windows open and enjoy the sights, sounds, and breeze of nature while keeping pests out. Combined with Clarity® mesh, FlexScreen is barely visible, so you don't need to sacrifice the beauty of your Window Nation windows or the outside view for the functionality of a screen.

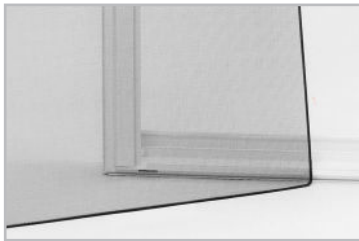

SIMPLE DESIGN

The revolutionary FlexScreen design utilizes a PVC-coated, high-performance spring-steel frame. The simple design eliminates the need for unnecessary attachment hardware—resulting in an aesthetically clean window.

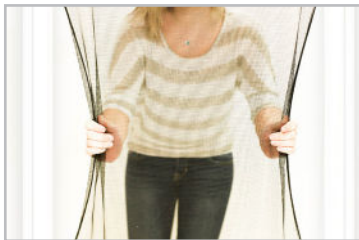

EFFORTLESS INSTALLATION

A major benefit of the FlexScreen is its simple installation. Simply hold the screen in your hands, bend the sides in, and fit FlexScreen into your screen track. It is really that easy. See page two for installation and removal instructions.

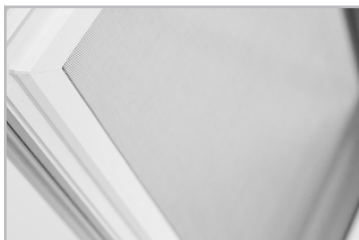

BEAUTIFULLY INVISIBLE

Your windows will never look better. Once installed in your window, the FlexScreen frame is concealed in the window screen pocket and disappears from sight, making your windows appear larger. Additionally, the subtle Clarity mesh screen drastically improves your view compared to standard screen material.

NEARLY INDESTRUCTIBLE

Bent frames, scratched paint, and broken hardware are a thing of the past. FlexScreen's durability is proven; it passed rigorous testing, including a 5-story fall with no damage. If your mesh screen is ever damaged, it can be easily replaced.



COMPLEMENTARY SLIDING GLASS DOOR

The Addison Series sliding glass door is the ideal solution to effortlessly blend interior and exterior spaces for your renovation project. Complete with multiple customization options, this elegant sliding glass door is sure to add a wow factor to your home. The multi-slide option is the perfect solution to create an expansive opening that seamlessly unites interior and exterior spaces.



GLAZING TYPE	U-VALUE	SHGC
Argon and Low-E glass	0.28	0.28
Argon and Low-E glass with grids	0.28	0.25
Argon and HP Low-E glass	0.28	0.20
Argon and HP Low-E glass with grids	0.28	0.18
Triple-pane with argon and Low-E glass	0.24	0.24
Triple-pane with argon and Low-E glass with grids	0.26	0.22

Best-in-class features:

- Saddle sill with heavy-duty dual rollers provide for easy operation
- Beveled exterior edge adds style and curb appeal to an already sleek design
- Interlock at meeting rail helps reduce air infiltration
- Dual-tandem nylon wheels
- Raised rail to protect wheels from debris
- Sturdy, all-aluminum track
- Available in 2,3,4 and 6-panel configurations that are set-up, knock-down, and multi-slide

BLINDS BETWEEN-THE-GLASS

This unique option offers a quality solution for sliding glass door treatments. The blinds are sealed between two panes of glass, resulting in a longer service life compared to standard blinds while also eliminating the need for dusting. Engineered for ease of use, the internal design makes raising and lowering the blinds simple and intuitive and eliminates the possibility of blinds obstructing the door operation.

HARDWARE:

Standard Handles



Enhanced Handle Finishes



Additional Features



DECORATIVE OPTIONS

COLOR OPTIONS

We offer a wide variety of color options to complement the interior or exterior style of your home. Classic extruded vinyl colors are enhanced by expertly applied interior woodgrains and rich-hued exterior finishes. Our high-performance exterior coatings provide low-maintenance, durable color while combining the look of wood-crafted windows with the energy-efficiency of vinyl.

Extruded Colors



Woodgrain Interior Laminates†



Painted Exterior Colors‡



* Clay not available on Addison Plus

† Woodgrain and painted exterior color options available on the Addison Plus double-hung, or any Addison window (except double-hung)

‡ Silver and black painted exteriors not available with woodgrain interiors

GRID OPTIONS

From simulated divided lite grids, which convey a historical look, to grids-between-the-glass, which allow for easy cleaning, our variety of grid options has something for everyone. Grids are available in numerous colors, sizes and patterns to help achieve your desired aesthetic.

Between-the-Glass



Simulated Divided Lite



THE WINDOW NATION COMMITMENT

Window Nation windows are manufactured by MI Windows and Doors, one of the nation's largest suppliers of high-quality windows for remodeling, replacement, and new construction projects. For residential applications, MI provides a lifetime transferable warranty for the mainframe of windows in its replacement window series. MI also offers a glass breakage warranty for products in its replacement series of windows and doors. Please refer to the complete product warranty for full details.



WindowNation.com
(866) 44-NATION



© 2023 MI Windows and Doors, LLC. All rights reserved.